



**A1101**

## IP VIDEO INDOOR STATION

For door communication in single-family residences  
and apartment buildings

 Designed,  
developed and  
made in Germany



The DoorBird IP Video Indoor Station is an ideal addition to every DoorBird IP Video Door Station. It features excellent video and audio quality, and its compact and discreet design blends in with any environment.

The display of the indoor station is made of scratch-resistant tempered glass. All functions are available within seconds via the intuitive user interface with clear symbols.

All main functions can be activated via the hardware buttons without having to use the touch screen.

This makes the operation

- intuitive and comfortable
- easy-to-use for every age group
- even with gloves on possible

The individual doorbell sound for the door, storey or gate helps to distinguish where the visitor presses the call button. At the same time, the LED status bar on the bottom of the indoor station illuminates in freely customizable colors.



Configurable tile view



Weather information



Table Stand \*A8003\* optional

In less than 10 minutes the installation of the indoor station is completed. It connects to the network via WiFi or a network cable. If the indoor station is connected using a network cable, it can be supplied with power comfortably via Power over Ethernet (PoE). If the Internet should fail, all functions of the indoor station and the connected DoorBird Door Stations continue to operate within the local network. Via the Internet, the indoor station can access all connected DoorBird door stations - anywhere in the world.

## FEATURES

### BENEFITS VIA IP

- Door opener and elevator control
- Visitor history (free Cloud Recording)
- Weather forecast
- Home and building automation control (IP, TCP, HTTPS, relays etc.)
- Configurable via the DoorBird App worldwide

### INTUITIVE USER INTERFACE

- 4" True Color Touch Display
- Scratch-resistant tempered Gorilla® glass

### TWO-WAY AUDIO

- HD Audio, up to 102 dB
- More than 50 doorbell sounds available

### COMPACT HOUSING

- 5 hardware buttons for main functions
- Configurable RGB LED status bar

### UNLIMITED RANGE

- Supports WiFi, Ethernet, PoE
- Support for multiple DoorBird IP Video Door Stations

### OPTIONAL FEATURES

- Concierge call
- Automatic door opening system, e.g. for offices
- SIP and PBX support

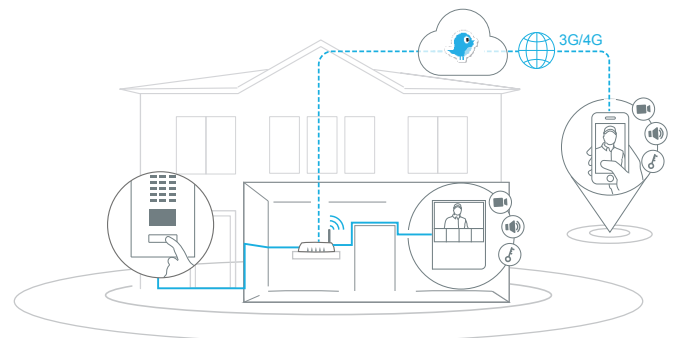

further installation examples s. page 5

## TECHNICAL SPECIFICATIONS



**DoorBird**  
Technology meets Design.

### GENERAL

Mounting type	Surface-mounted, Table Stand "A8003" sold separately
Power supply	15 - 48 V DC (max. 15 W) or Power over Ethernet (PoE 802.3af Mode-A)
Weight	336 g
Connectors	<ul style="list-style-type: none"> <li>• LAN/PoE (T+, T-, R+, R-)</li> <li>• Digital input (0 V, 0 A (NO)) #1, e.g. for storey-call button</li> <li>• Digital input (0 V, 0 A (NO)) #2, e.g. for second storey-call button</li> <li>• Bi-stable latching relay #1, max. 24 V DC/AC, 1 Ampere, e.g. for electric door opener or elevator</li> <li>• Bi-stable latching relay # 2, max. 24 V DC/AC, 1 Ampere, e.g. for electric door opener or elevator</li> <li>• Bi-stable latching relay # 3, max. 24 V DC/AC, 1 Ampere, e.g. for electric door opener or elevator</li> <li>• 15 - 48 V DC input (+, -), max. 15 W</li> </ul>
Power consumptions	5 W
Approvals	CE, FCC, IC, RoHS, IP50
Dimensions	179.5 x 115 x 25 mm (H x W x D) 7.07 x 4.53 x 0.98 in (H x W x D)
Operating conditions	0 to +55°C / 32 to 131°F Humidity 0 % to 85 % (non condensing)
Scope of delivery	<ul style="list-style-type: none"> <li>1 x IP Video Indoor Station</li> <li>1 x Mounting bracket</li> <li>1 x Power supply unit (main adaptor) with four country-specific adaptors (110 - 240 V AC to 15 V DC)</li> <li>1x Quickstart guide with Digital Passport</li> <li>1 x Installation manual</li> <li>1 x Small parts</li> </ul>
EAN	4260423860902
Warranty	see <a href="http://www.doorbird.com/warranty">www.doorbird.com/warranty</a>

### CURRENT SYSTEM REQUIREMENTS

System requirements	<p>Mobile device: Newest iOS on iPhone/iPad, newest Android on Smartphone/Tablet</p> <p>Internet: High-Speed Landline Broadband Internet connection, DSL, cable or fiber optic, no socks or proxy server</p> <p>Network: Ethernet Network, with DHCP</p>
Supported door stations	Any DoorBird IP Video Door Station

### DISPLAY

Dimensions	4" True Color LCD
Touch	Yes, capacitive
Resolution	800 x 480 px
IPS	Yes

### AUDIO

Audio components	Speaker and microphone, echo and noise cancellation (AEC, ANR)
Audio streaming	Two-way

### NETWORK

Ethernet	PoE 802.3af Mode-A
WiFi	802.11 b/g/n 2.4 GHz

[www.doorbird.com](http://www.doorbird.com)

### INTEGRATED WIRELESS MODULES

WiFi	802.11 b/g/n 2.4 GHz
------	----------------------

### OPTIONAL ACCESSORIES

Sold separately	see <a href="http://www.doorbird.com/buy">www.doorbird.com/buy</a>
-----------------	--

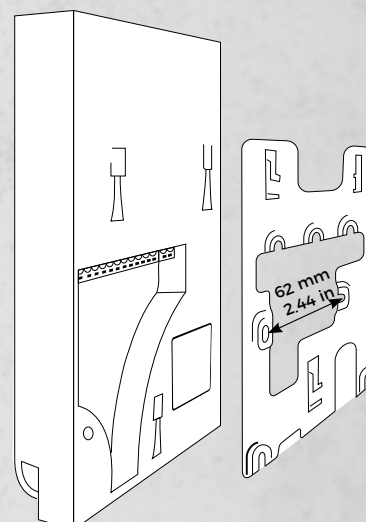
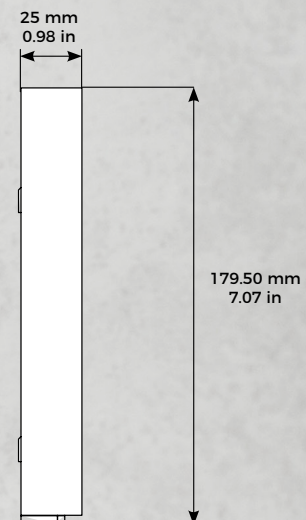
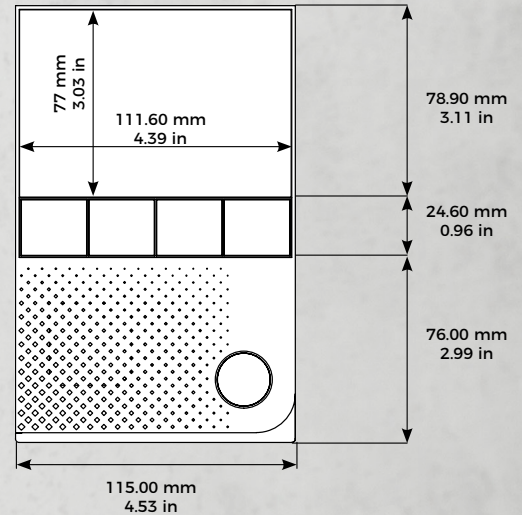

ONE INDOOR STATION VIA NETWORK CABLE

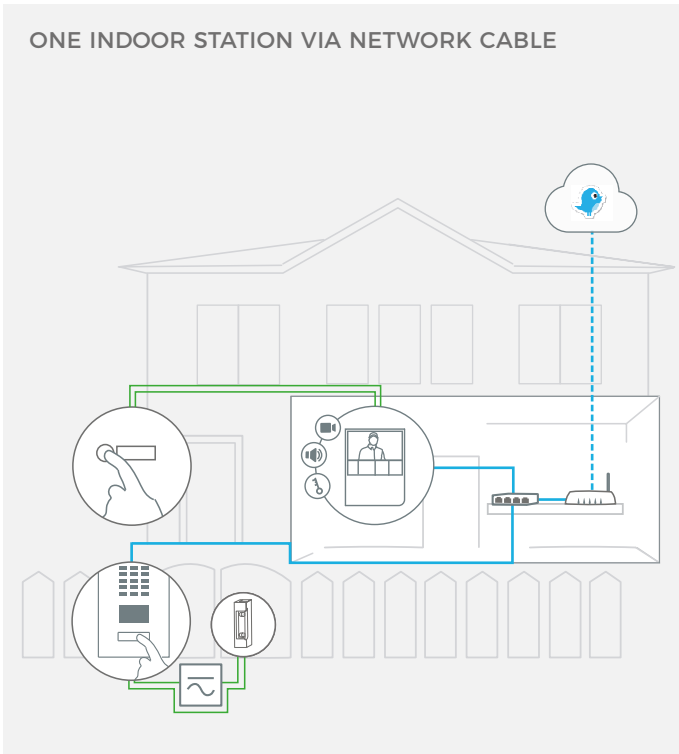

ONE INDOOR STATION VIA WIFI

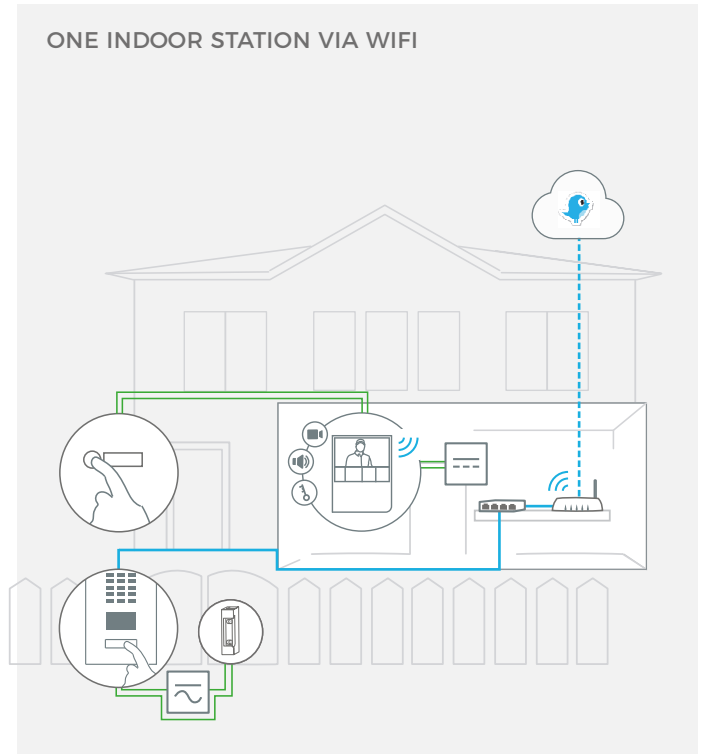

THREE INDOOR STATIONS VIA NETWORK CABLE

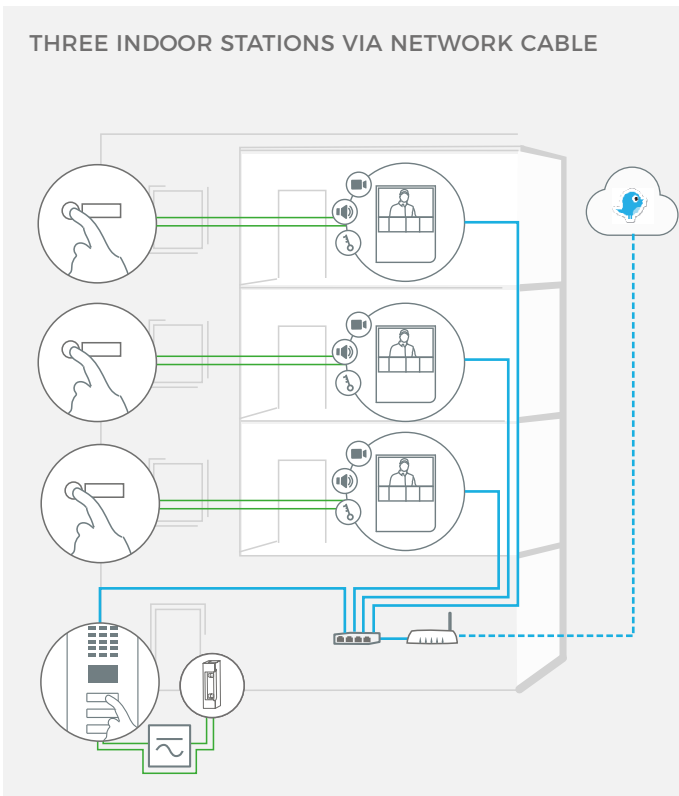

THREE INDOOR STATIONS VIA WIFI

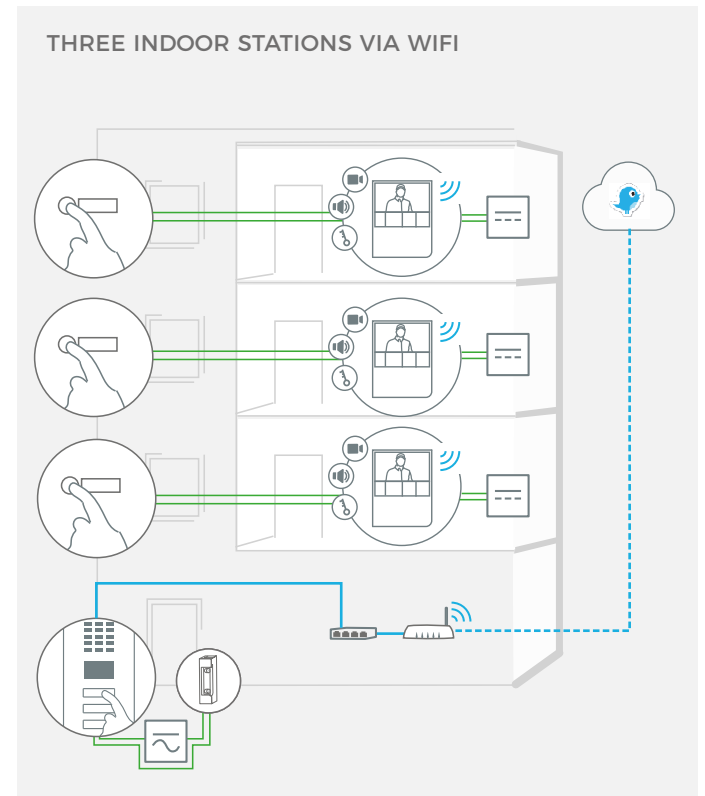

Storey-call button



Indoor Station



DoorBird IP Video Door Station



Electric door or gate opener. Can be secured via DoorBird I/O Door Controller if required (remote safety relay)



Power over Ethernet (PoE) Switch



Router with High-speed Internet, DHCP



Separate power supply 15 V DC, 1 A



Separate power supply 12 V DC, 1 A

— Network cable

— 2-wire-cable